

# PRORIL

## SLURRY & SAND PUMPS



50 Hz

A large yellow tracked vehicle, possibly a sand pump or conveyor, is positioned on a massive pile of sand. The vehicle has a boxy, industrial design with a cab and various mechanical components. The sand pile is light-colored and shows signs of erosion or being worked on. In the foreground, there is a body of water, likely a slurry pond, with a dark, muddy surface. The sky is blue with scattered white clouds. A blue diagonal graphic element is visible in the bottom right corner.

# SLURRY & SAND PUMPS

Serving a wide range of slurry transport applications, PRORIL's slurry pumps are designed for long wear life, low energy consumption, excellent performance, and easy maintenance. With our patented ACRS Tech and rugged construction, these abrasion and corrosion resistant slurry pumps provide economical solutions for challenging slurry transportation.



# STORMY SERIES

## OPEN STAND AND AGITATOR, STRAINER AND AGITATOR

Rugged, reliable and cost effective, the Stormy series pumps come complete with patented high chrome impellers, agitators, and wear plates to withstand tough slurry transportation. STORMY pumps are designed with two different types of pump stands, the open stand and the strainer. Our slurry pumps serve a wide range of slurry transport applications like mining, quarrying, construction sites, and other demanding industries.

### FEATURES

#### 1 Watertight Cable Entry

The cable entry employs an anti-wicking block where each conductor is stripped and encapsulated in epoxy. This feature effectively prevents water from penetrating the motor chamber when the cable end is submerged or the cable sheath is damaged.

#### 2 Top Discharge and Side Flow Design

Designed to cool the motor with pumped water even at low water level, this feature forms the cylindrical and slim shape of the pump and enables the pump to be installed in confined spaces.

#### 3 Motor Protector

The motor incorporates a circle thermal protector which protects against overheating and dry-run.

#### 4 Submersible 4-Pole Motor

Air filled motor, housed in a watertight casing, conforms to Class F insulation. The 4-pole motor helps reducing impeller wears.

#### 5 C3 Ball Bearings and Hardened SS Shaft

High quality of C3 ball bearings and the well-balanced, hardened stainless steel shaft enhance stability during continuous pumping operations.

#### 6 Double Mechanical Seals

Located in the oil chamber, the device is made of quality materials with highly wear-resistant silicon carbide in lower side that provides extra protection against leakage and dry-run.

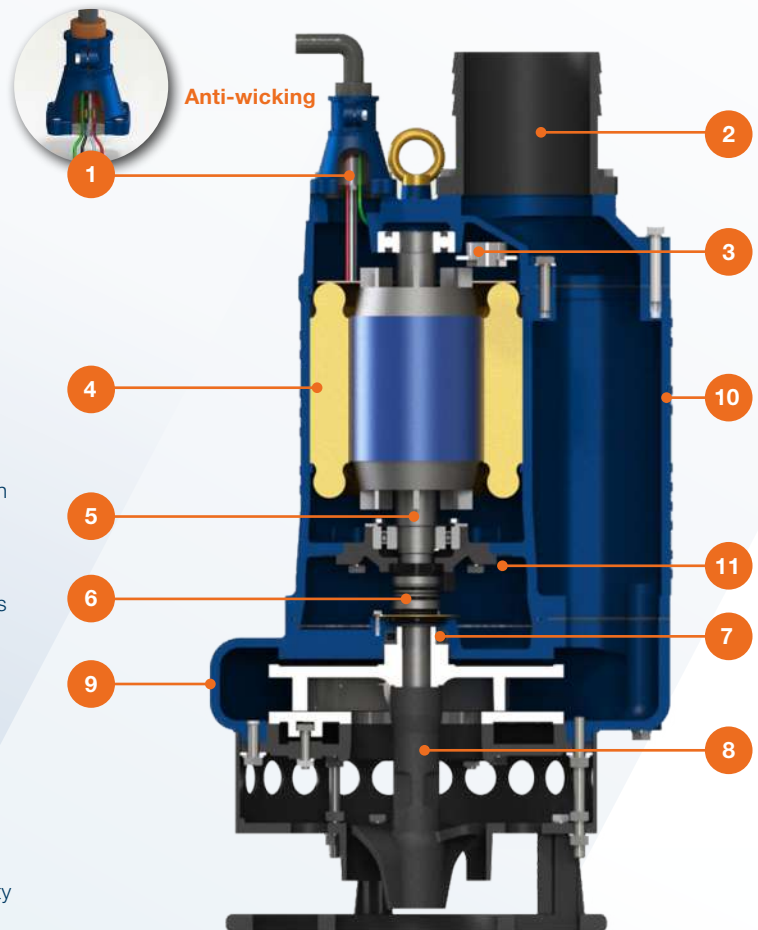

The above images are for illustration purposes only, please refer to datasheets for more details.

#### 7 Extra Protection for Mechanical Seals and Shaft

Lip seals and shaft sleeves are utilized for additional protection against wear.

#### 8 High Chrome Iron Impeller, Agitator, and Wear plate

PRORIL patent formula, ACRs Tech is applied to all high chrome iron components, including impellers, agitators, and wear plates. This technology increases wear resistance to particle abrasion.

#### 9 Hardened Pump Volute

The pump volute is made from hardened cast ductile iron. This technology enhances the hardness and wear life of the pump casing.

#### 10 Rugged Cast Iron Construction

The whole cast iron pump features a simple, robust structure that provides durability and impact resistance to rough conditions.

#### 11 Food Grade Lubricant

PRORIL adopts eco-friendly lubricant to minimize environmental impacts.





## Advanced Chromium Steel Tech

After years of testing and continuous improvement, PRORIL proudly presents our patented technology, Advanced Chromium Steel Tech, ACrS Tech. Designed for high wear resistance and superb corrosion resistance, ACrS Tech is applied to all our dewatering and slurry pump family to tackle tough challenging applications. The advantages of ACrS Tech can easily and dramatically reduce operational costs.



### STORMY

### 337 437



STORMY	337	437
Outlet	3" (80mm)	4" (100mm)
Rated Output	3.7kW	3.7kW
Shaft Speed	1450 rpm	1450 rpm
Solid Passage	25mm	25mm
Height <b>P</b>	762mm	783mm
Height <b>S</b>	793mm	814mm
Diameter <b>P</b>	Ø385mm	Ø385mm
Diameter <b>S</b>	Ø382mm	Ø382mm
Weight <b>P</b>	110kg	110kg
Weight <b>S</b>	115kg	115kg

**P** : Open Stand

**S** : Strainer

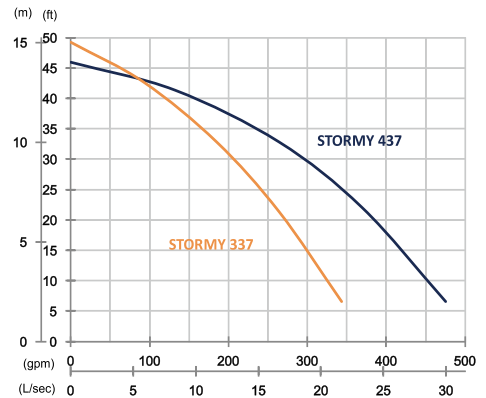

### STORMY

### 355 455



STORMY	355	455
Outlet	3" (80mm)	4" (100mm)
Rated Output	5.5kW	5.5kW
Shaft Speed	1450 rpm	1450 rpm
Solid Passage	25mm	25mm
Height <b>P</b>	806mm	826mm
Height <b>S</b>	806mm	826mm
Diameter <b>P</b>	Ø420mm	Ø420mm
Diameter <b>S</b>	Ø412mm	Ø412mm
Weight <b>P</b>	123kg	124kg
Weight <b>S</b>	131kg	132kg

**P** : Open Stand

**S** : Strainer

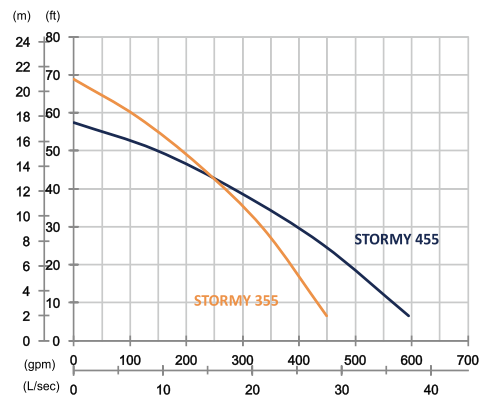

# STORMY

## 475



(P)

(S)

STORMY	475
Outlet	4" (100mm)
Rated Output	7.5kW
Shaft Speed	1450 rpm
Solid Passage	25mm
Height (P)	826mm
Height (S)	826mm
Diameter (P)	Ø420mm
Diameter (S)	Ø412mm
Weight (P)	124kg
Weight (S)	132kg

(P) : Open Stand

(S) : Strainer

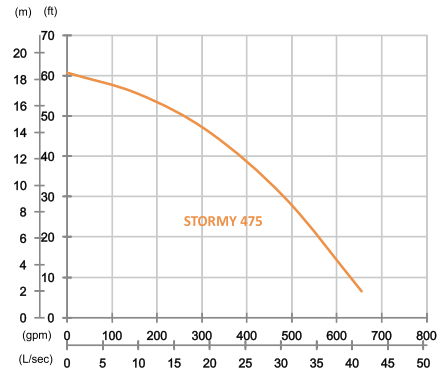

# STORMY

## 4110 6110



(P)

(S)

STORMY	4110	6110
Outlet	4" (100mm)	6" (150mm)
Rated Output	11kW	11kW
Shaft Speed	1450 rpm	1450 rpm
Solid Passage	25mm	35mm
Height (P)	901mm	913mm
Height (S)	910mm	922mm
Diameter (P)	Ø479mm	Ø479mm
Diameter (S)	Ø479mm	Ø479mm
Weight (P)	191kg	192kg
Weight (S)	199kg	200kg

(P) : Open Stand

(S) : Strainer

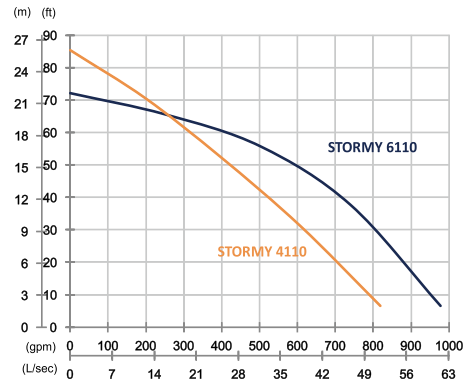

# STORMY

## 6150 6150L



(P)

(S)

STORMY	6150	6150L
Outlet	6" (150mm)	6" (150mm)
Rated Output	15kW	15kW
Shaft Speed	1450 rpm	1450 rpm
Solid Passage	35mm	35mm
Height (P)	913mm	913mm
Height (S)	922mm	922mm
Diameter (P)	Ø479mm	Ø479mm
Diameter (S)	Ø479mm	Ø479mm
Weight (P)	201kg	201kg
Weight (S)	208kg	208kg

(P) : Open Stand

(S) : Strainer

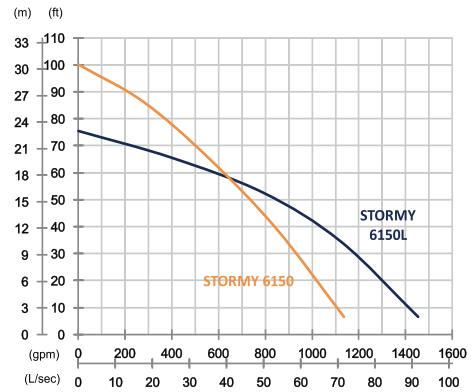

# STORMY

## 6220 8220



(P)

(S)

STORMY	6220	8220
Outlet	6" (150mm)	8" (200mm)
Rated Output	22kW	22kW
Shaft Speed	1450 rpm	1450 rpm
Solid Passage	30mm	35mm
Height (P)	1204mm	1166mm
Height (S)	1210mm	1172mm
Diameter (P)	Ø592mm	Ø592mm
Diameter (S)	Ø592mm	Ø592mm
Weight (P)	345kg	355kg
Weight (S)	357kg	367kg

(P) : Open Stand

(S) : Strainer

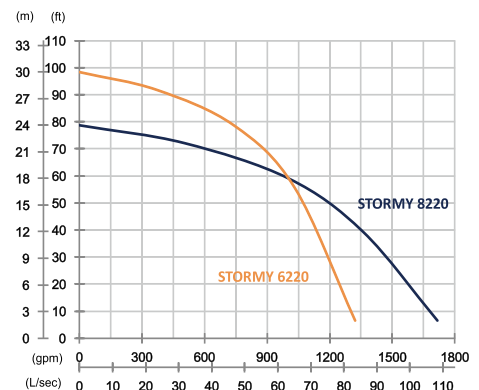

---

## PRORIL

---

PRORIL was established in 1979, starting from a small motor factory where it has transformed itself into a global size submersible pump manufacturer. Its perseverance and dedication of making high quality products and maintaining a strong working etiquette are mere images of the founder's belief and philosophy that contribute to the success of PRORIL.

With decades of experiences, PRORIL specializes in submersible pump manufacturing service, and continues investing in the fluid dynamics design, motor efficiency enhancement, and R&D of various metal alloys. The integration of upstream and downstream suppliers has completed the manufacturing chain that PRORIL proudly offers to its customers. PRORIL goes through stringent quality procedures where its quality management system conforms to the global standards.

Up to now, PRORIL had recognized by various international awards by the persistence of product quality and continuous improvement according to market demand. Through the recognition of the awards, PRORIL is more determined to provide better services and products to customers.

Today, PRORIL has developed a complete product line that covers dewatering pumps, sewage pumps, slurry pumps, and others. They are applicable in general drainage, construction, industrial sites, wastewater treatment, sludge removal, and so on. Furthermore, PRORIL's professional R&D team continuously improves the product performance to meet various needs in tough dewatering applications.

The success of PRORIL has been based on unyielding commitment and attitude to technical excellence and unparalleled dedication to customer service. Honesty and integrity have further contributed to a worldwide collaboration and connection to a long-term sustainable relationship with all our customers.

In future, PRORIL will continue to excel and serve every PRORIL's customer with our professionalism, enthusiasm, and trust.



---

## MORE PRODUCTS

---



**DEWATERING PUMPS**



**HANDY & RESIDUE PUMPS**



**SEWAGE PUMPS**



**STAINLESS STEEL PUMPS**

**PRORIL** 

**PRORIL PUMPS CORPORATION**

SL-50-108001

[WWW.PRORIL.COM](http://WWW.PRORIL.COM)

 **DESIGN  
AWARD**